

SPECIFICATIONS

CONTACT RESISTANCE: 30mΩ max
 INSULATION RESISTANCE: DC 500V 100MΩ min
 DIELECTRIC STRENGTH: AC 1000V 1 minute
 ELECTRICAL LIFE: 30,000 cycles min
 MECHANICAL LIFE: 50,000 cycles min
 TERMINAL MATERIAL: Copper alloy,
 silver or gold plated

BUTTON COLOR CHART:

| COLOR NO. | COLOR | COLOR NO. | COLOR |
|-----------|------------|-----------|--------|
| 1 | White | 5 | Yellow |
| 2 | Black | 6 | Green |
| 3 | Red (Std.) | 7 | Blue |

*RoHS Compliant: Please add a code "H" to part number. □
 For example: R18-25A-3-H

INDEX

TOGGLE

ROCKER

SLIDE

PUSHBUTTON

DIP

TACT

3A 125V AC



| Model No. | TYPE |
|-----------|----------|
| R18-21A | OFF-ON |
| R18-21B | OFF-(ON) |
| R18-21C | ON-(OFF) |

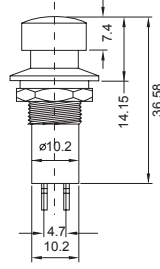
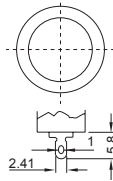

3A 125V AC



| Model No. | TYPE |
|-----------|----------|
| R18-23A | OFF-ON |
| R18-23B | OFF-(ON) |
| R18-23C | ON-(OFF) |

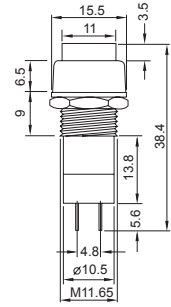
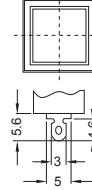

3A 125V AC



| Model No. | TYPE |
|-----------|----------|
| R18-24A | OFF-ON |
| R18-24B | OFF-(ON) |

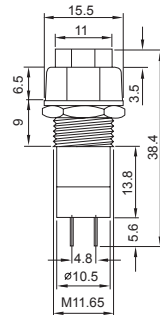
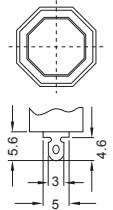

3A 125V AC



| Model No. | TYPE |
|-----------|----------|
| R18-25A | OFF-ON |
| R18-25B | OFF-(ON) |
| R18-25C | ON-(OFF) |

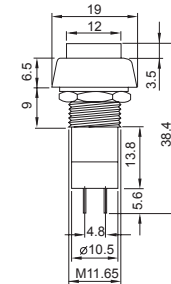
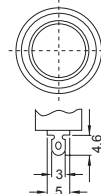

3A 125V AC



| Model No. | TYPE |
|-----------|----------|
| R18-26A | OFF-ON |
| R18-26B | OFF-(ON) |

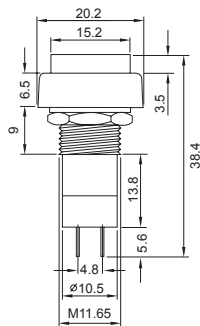
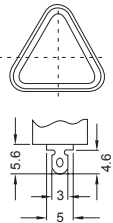

1A 125V AC



| Model No. | TYPE |
|-----------|----------|
| R18-27A | OFF-(ON) |
| R18-27B | ON-(OFF) |

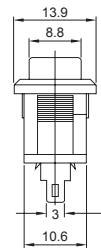
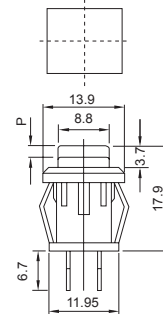

1A 125V AC



| Model No. | TYPE |
|-----------|----------|
| R18-28A | OFF-(ON) |

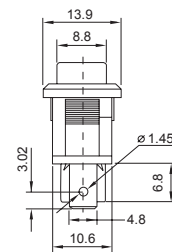
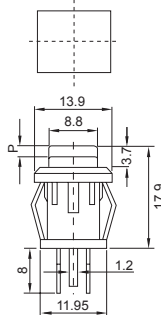

1A 125V AC



| Model No. | TYPE |
|-----------|----------|
| R18-27C | ON-(OFF) |

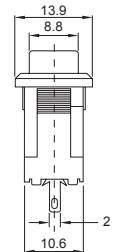
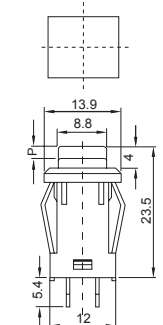

1A 125V AC



| Model No. | TYPE |
|-----------|----------|
| R18-29A | OFF-(ON) |
| R18-29C | ON-(OFF) |

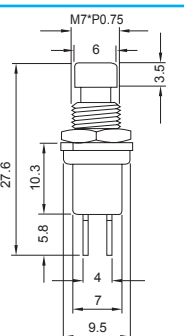
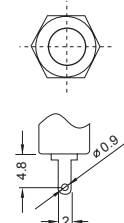

1A 125V AC



| Model No. | TYPE |
|-----------|----------|
| R18-29B | ON-(OFF) |

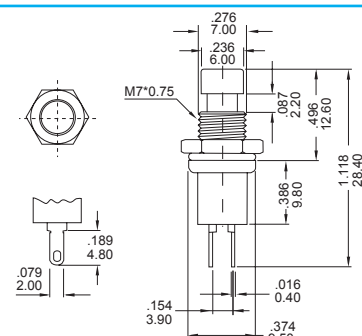



R18

Pushbutton Switches



SPECIFICATIONS

| | |
|------------------------|-------------------|
| CONTACT RESISTANCE: | DC 5V 1A 30mΩ max |
| INSULATION RESISTANCE: | DC 500V 100Ω min |
| DIELECTRIC STRENGTH: | AC 500V 1 minute |
| ELECTRICAL LIFE: | 30,000 cycles |
| MECHANICAL LIFE: | 50,000 cycles |
| OPERATION FORCE: | 500 ± 150g |

*RoHS Compliant: Please add a code "H" to part number. For example: S18-23A-H

S18-21



| Model No. | TYPE |
|-----------|----------|
| S18-21A | OFF-ON |
| S18-21B | OFF-(ON) |

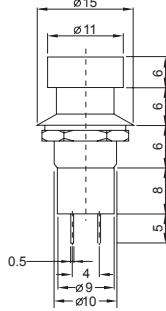
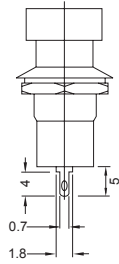

3A 125V AC

S18-23



| Model No. | TYPE |
|-----------|----------|
| S18-23A | OFF-ON |
| S18-23B | OFF-(ON) |

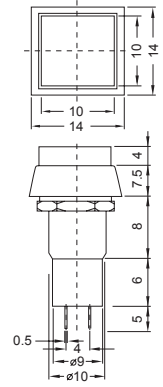
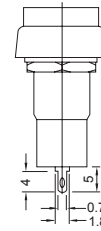

3A 125V AC

S18-25



| Model No. | TYPE |
|-----------|----------|
| S18-25A | OFF-ON |
| S18-25B | OFF-(ON) |

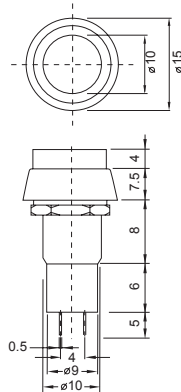
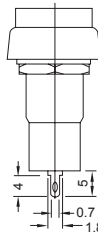

3A 125V AC

R18-36A

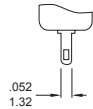
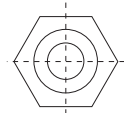
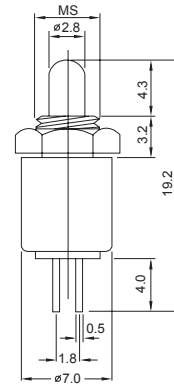

0.5A 125V AC

INDEX

TOGGLE

ROCKER

SLIDE

PUSHBUTTON

DIP

TACT